

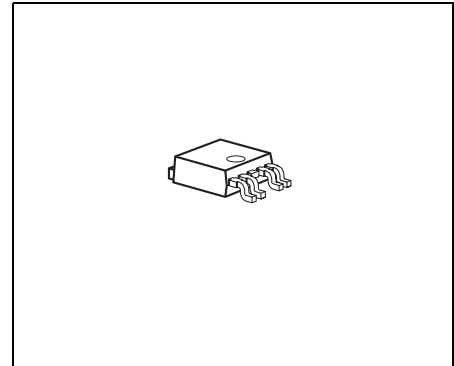

Features

- Output 1: 350 mA; 3.3 V \pm 4%
- Output 2: 430 mA; 5.0 V \pm 4%
- Enable input for output 2
- Low quiescent current in OFF state
- Wide operation range: up to 42 V
- Reverse battery protection: up to 42 V
- Output protected against short circuit
- Wide temperature range: -40 °C to 170 °C
- Overvoltage protection up to 65 V (< 400 ms)
- Overtemperature protection
- Overload protection
- Green Product (RoHS compliant)
- AEC Qualified



Functional Description

The TLE 4476 is a monolithic integrated voltage regulator providing two output voltages, Q1 is a 3.3 V output for loads up to 350 mA and Q2 is a 5 V output providing 430 mA. The device is available in the PG-TO252-5-11 (D-Pak) package. Output 2 can be switched ON/OFF via the Enable input EN.

The TLE 4476 is designed to supply microprocessor systems under the severe conditions of automotive applications and is therefore equipped with additional protection functions against overload, short circuit and overtemperature.

Type	Package
TLE 4476 D	PG-TO252-5-11

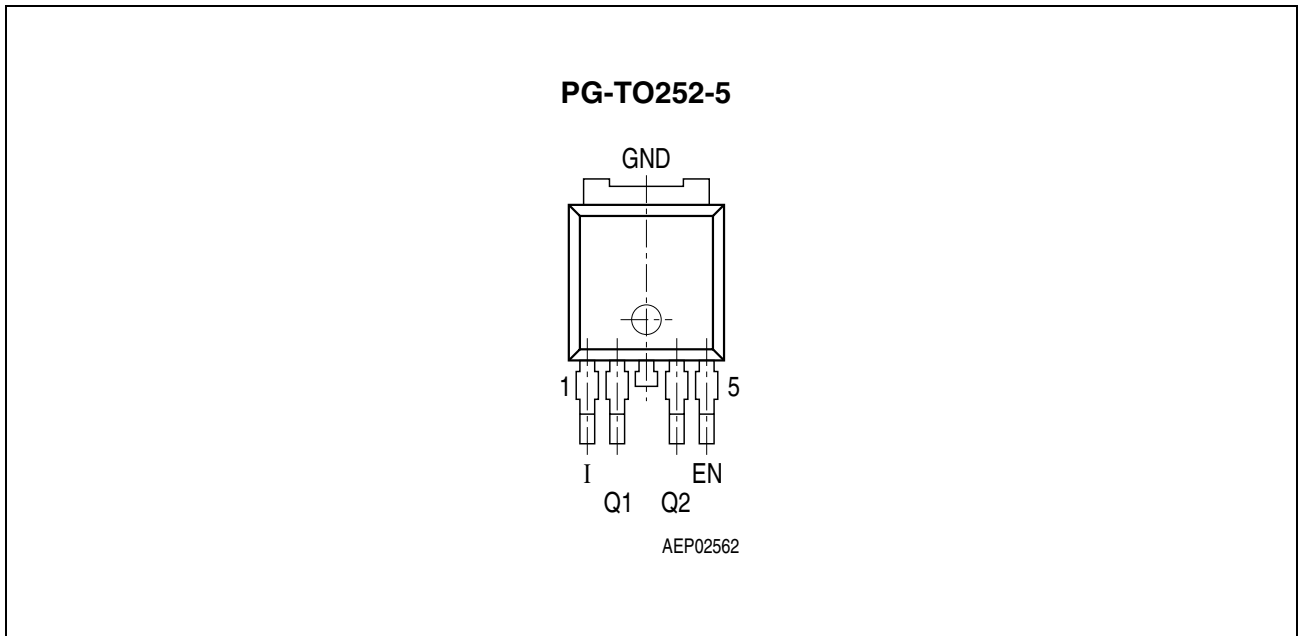

Figure 1 Pin Configuration (top view)

Table 1 Pin Definitions and Functions

Pin No.	Symbol	Function
1	I	Input voltage; block to GND directly at the IC with a ceramic capacitor
2	Q1	3.3 V output; block to GND with a capacitor $C_{Q1} \geq 10 \mu\text{F}$, $\text{ESR} < 2 \Omega$ at 10 kHz
3	GND	Ground
4	Q2	5.0 V output; block to GND with a capacitor $C_{Q2} \geq 10 \mu\text{F}$, $\text{ESR} < 3 \Omega$ at 10 kHz
5	EN	Enable input; to switch ON and OFF Q2, ON with high signal

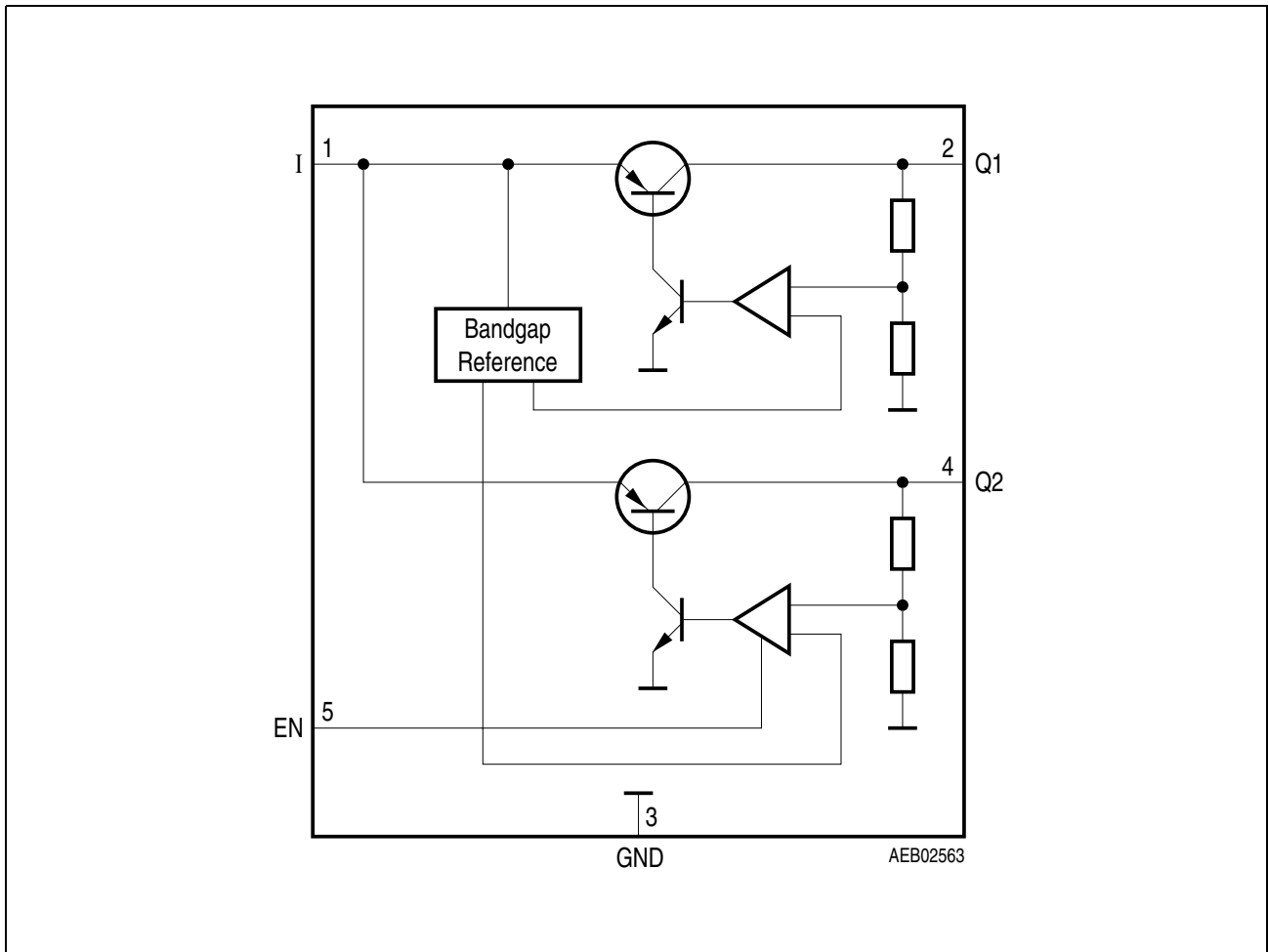

Figure 2 **Block Diagram**

Table 2 Absolute Maximum Ratings

$-40\text{ °C} < T_j < 170\text{ °C}$

Parameter	Symbol	Limit Values		Unit	Remarks
		Min.	Max.		
Input I					
Voltage	V_I	-42	42	V	– $t < 400\text{ ms}$
		–	65	V	
Current	I_I	–	–	mA	Internally limited
3.3 V Output Q1					
Voltage	V_{Q1}	-1	36	V	–
Current	I_{Q1}	–	–	mA	Internally limited
5.5 V Output Q2					
Voltage	V_{Q2}	-1	36	V	–
Current	I_{Q2}	–	–	mA	Internally limited
Inhibit EN					
Voltage	V_{EN}	-42	42	V	– $t < 400\text{ ms}$
		–	65	V	
Current	I_{EN}	–	–	mA	Internally limited
Temperatures					
Junction temperature	T_j	-50	170	°C	–
Storage temperature	T_{stg}	-50	150	°C	–

Notes

1. ESD-Protection according to MIL Std. 883: $\pm 2\text{ kV}$.
2. Stresses above those listed here may cause permanent damage to the device. Exposure to absolute maximum rating conditions for extended periods may affect device reliability.

Table 3 Operating Range

Parameter	Symbol	Limit Values		Unit	Remarks
		Min.	Max.		
Output 1 input voltage	V_{I1}	4.5	42	V	1)
Output 2 input voltage	V_{I1}	5.7	42	V	2)
3.3 V regulator output current	I_{O1}	0	350	mA	–
5 V regulator output current	I_{O2}	0	430	mA	–
Junction temperature	T_j	-40	170	°C	3)

Thermal Resistances

Junction case	$R_{th,j-case}$	–	3	K/W	–
Junction ambient	$R_{th,j-a}$	–	80	K/W	4)

- 1) Input voltage V_I required for operation of output Q1
- 2) Input voltage V_I required for operation of output Q2
- 3) The overtemperature protection is set to > 170 °C. The voltage regulator may not be operated continuously at 170 °C as device reliability will be reduced to 500 h statistic lifetime.
- 4) Worst case regarding peak temperature, zero airflow; mounted on a PCB 80 × 80 × 1.5 mm³, 35 μm Cu, 5 μm Sn, heat sink area 300 mm².

Note: In the operating range the functions given in the circuit description are fulfilled.

Table 4 Electrical Characteristics
 $V_I = 13.5 \text{ V}; V_{EN} > V_{ENH}; -40 \text{ }^\circ\text{C} < T_j < 150 \text{ }^\circ\text{C};$ unless otherwise specified.

Parameter	Symbol	Limit Values			Unit	Test Condition
		Min.	Typ.	Max.		
3.3 V Output Q1						
Output voltage	V_{Q1}	3.17	3.3	3.43	V	$1 \text{ mA} < I_{Q1} < 250 \text{ mA}$
Output current limitation	I_{Q1}	350	–	900	mA	¹⁾
Load regulation	ΔV_{Q1}	–	–	30	mV	$1 \text{ mA} < I_{Q1} < 250 \text{ mA}$
Line regulation	ΔV_{Q1}	–	–	20	mV	$I_{Q1} = 5 \text{ mA};$ $6 \text{ V} < V_I < 28 \text{ V}$
Power Supply Ripple Rejection	<i>PSRR</i>	–	60	–	dB	$20 \text{ Hz} < f_r < 20 \text{ kHz}^{2)}$; $V_r = 5 \text{ Vpp}$
Output capacitor	C_{Q1}	10	–	–	μF	–
ESR of output capacitor	R_{ESRQ1}	–	–	2	Ω	at 10 kHz
5.0 V Output Q2						
Output voltage	V_{Q2}	4.8	5.0	5.2	V	$1 \text{ mA} < I_{Q2} < 330 \text{ mA}$
Output current limitation	I_{Q2}	430	–	900	mA	¹⁾
Drop voltage; $V_{DRQ2} = V_I - V_{Q2}$	V_{DRQ2}	–	0.3	0.7	V	$I_{Q2} = 330 \text{ mA}^{1)}$
Load regulation	ΔV_{Q2}	–	–	50	mV	$5 \text{ mA} < I_{Q2} < 330 \text{ mA}$
Line regulation	ΔV_{Q2}	–	–	50	mV	$I_{Q2} = 5 \text{ mA};$ $6 \text{ V} < V_I < 28 \text{ V}$
Power Supply Ripple Rejection	<i>PSRR</i>	–	60	–	dB	$20 \text{ Hz} < f_r < 20 \text{ kHz}^{2)}$; $V_r = 5 \text{ Vpp}$
Output capacitor	C_{Q2}	10	–	–	μF	–
ESR of output capacitor	R_{ESRQ2}	–	–	3	Ω	at 10 kHz

Table 4 Electrical Characteristics (cont'd)
 $V_I = 13.5 \text{ V}; V_{EN} > V_{ENH}; -40 \text{ }^\circ\text{C} < T_j < 150 \text{ }^\circ\text{C};$ unless otherwise specified.

Parameter	Symbol	Limit Values			Unit	Test Condition
		Min.	Typ.	Max.		
Current Consumption						
Quiescent current; $I_q = I_I - I_{Q1}$	I_q	–	100	150	μA	$T_j < 85 \text{ }^\circ\text{C};$ $V_{EN} = 0 \text{ V}$
Quiescent current; $I_q = I_I - I_{Q1} - I_{Q2}$	I_q	–	300	400	μA	$I_{Q1} = I_{Q2} = 300 \text{ } \mu\text{A};$ $T_j < 85 \text{ }^\circ\text{C}$
Quiescent current; $I_q = I_I - I_{Q1} - I_{Q2}$	I_q	–	2.5	10	mA	$I_{Q1} = 150 \text{ mA};$ $I_{Q2} = 300 \text{ } \mu\text{A}$
Quiescent current; $I_q = I_I - I_{Q2} - I_{Q1}$	I_q	–	5	13	mA	$I_{Q1} = 300 \text{ } \mu\text{A};$ $I_{Q2} = 250 \text{ mA}$
Enable Input EN						
EN ON voltage	$V_{EN \text{ ON}}$	1.8	–	–	V	$V_{Q2} \text{ ON}$
EN OFF voltage	$V_{EN \text{ OFF}}$	–	–	1.0	V	$V_{Q2} \text{ OFF}$
Input current	V_{EN}	–	20	30	μA	$V_{EN} = 13 \text{ V}$

- 1) Measured when the output voltage V_Q has dropped 100 mV from the nominal value.
- 2) Guaranteed by design.

Application Information

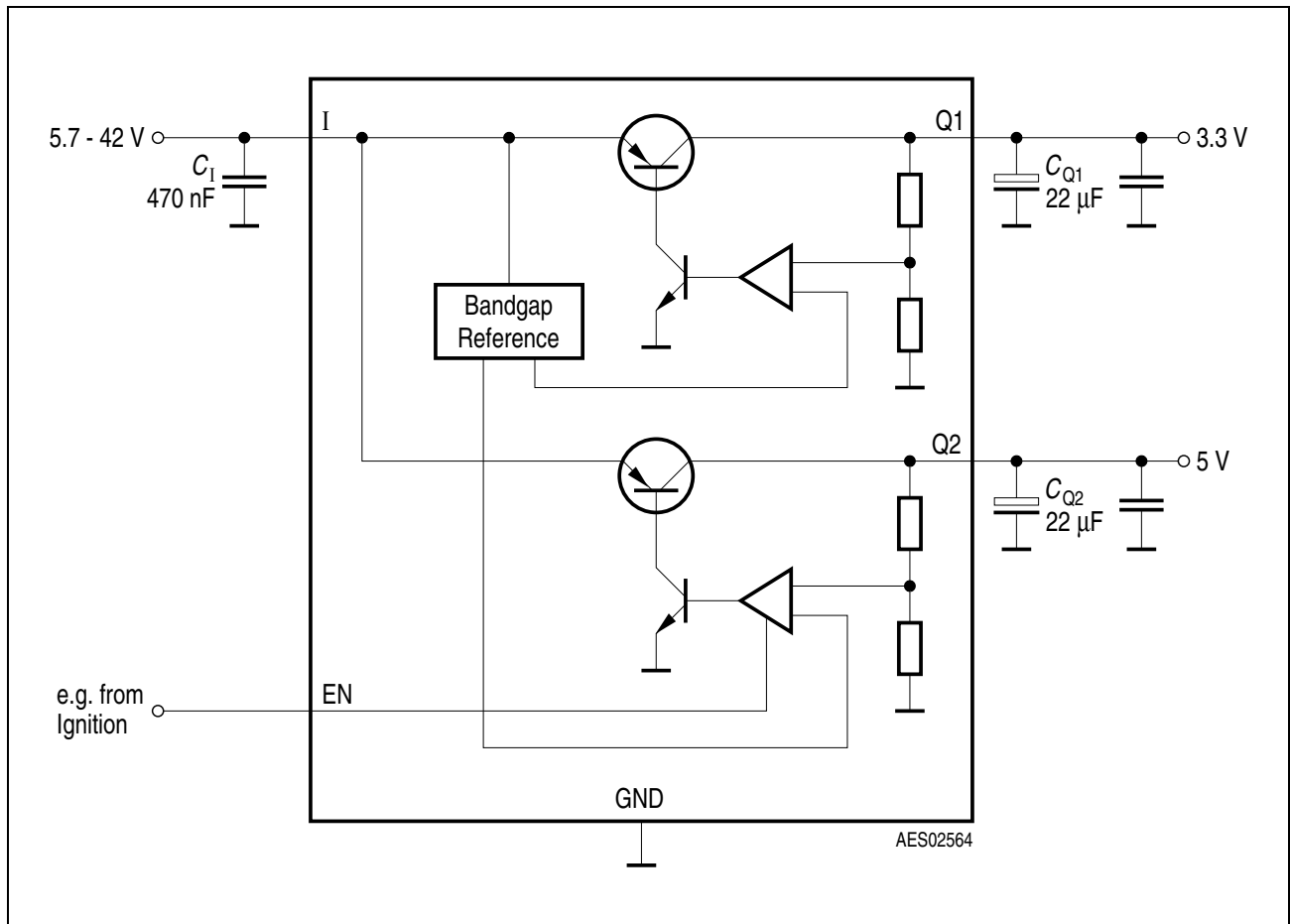

Figure 3 Application Circuit

Input, Output

The input capacitor C_1 is necessary for compensating line influences. Using a resistor of approx. 1Ω in series with C_1 , the LC circuit of input inductivity and input capacitance can be damped. To stabilize the regulation circuits of the stand-by and main regulator, output capacitors C_{Q1} and C_{Q2} are necessary. Stability is guaranteed at values $C_{Q1} \geq 10 \mu\text{F}$ ($\text{ESR} \leq 2 \Omega$) and $C_{Q2} \geq 10 \mu\text{F}$ ($\text{ESR} \leq 3 \Omega$) within the operating temperature range.

Enable

Using the enable feature the output 2 (5 V output) can be switched ON or OFF. The enable input can be connected directly to terminal 30 (battery line) or 15 (ignition line). It is also possible to control the output 2 via the microcontroller.

Typical Performance Characteristics

Output Current I_{Q1} versus Input Voltage V_I

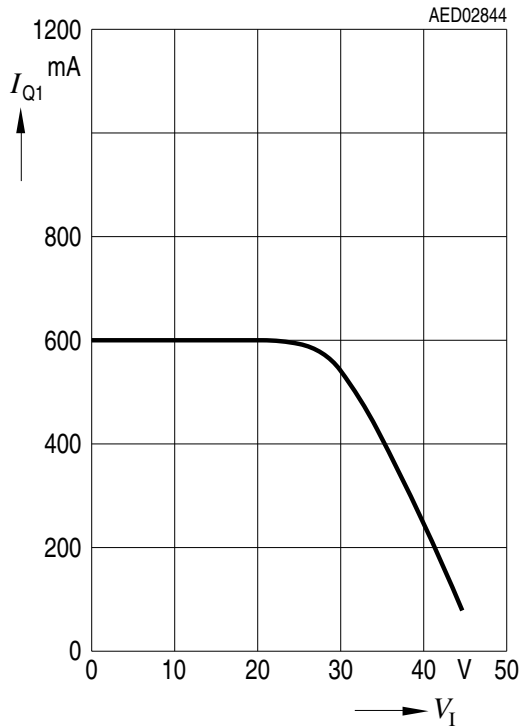

Output Current I_{Q2} versus Input Voltage V_I Enable ON

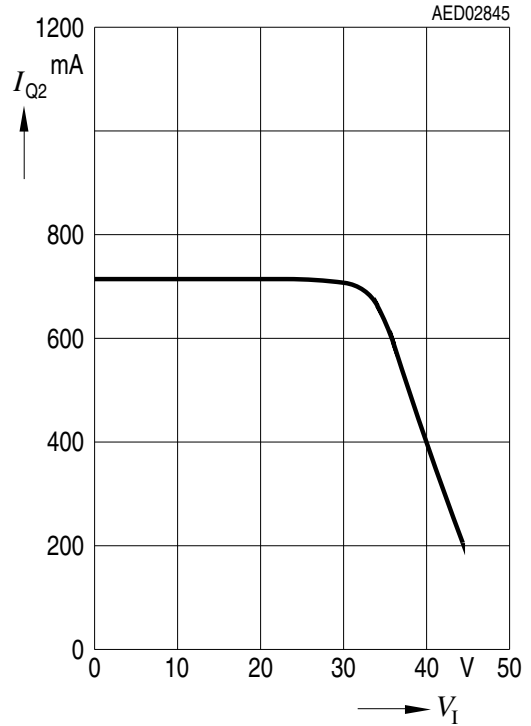

Output Voltage V_{Q2} versus Temperature T_j

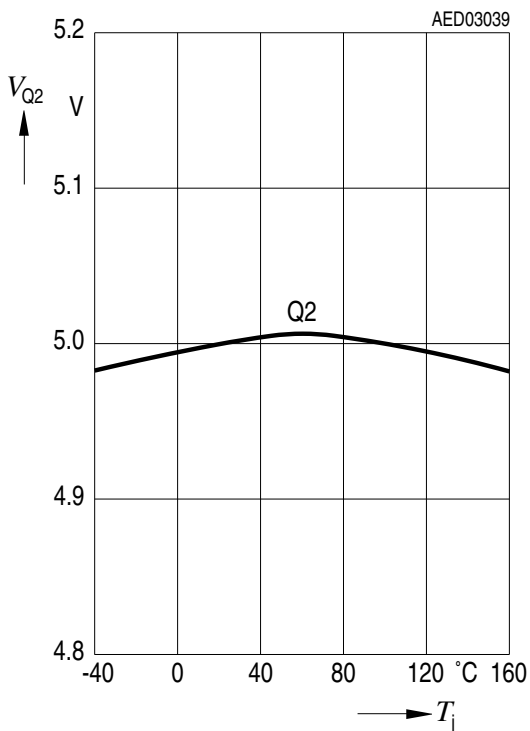

Output Voltage V_{Q1} versus Temperature T_j

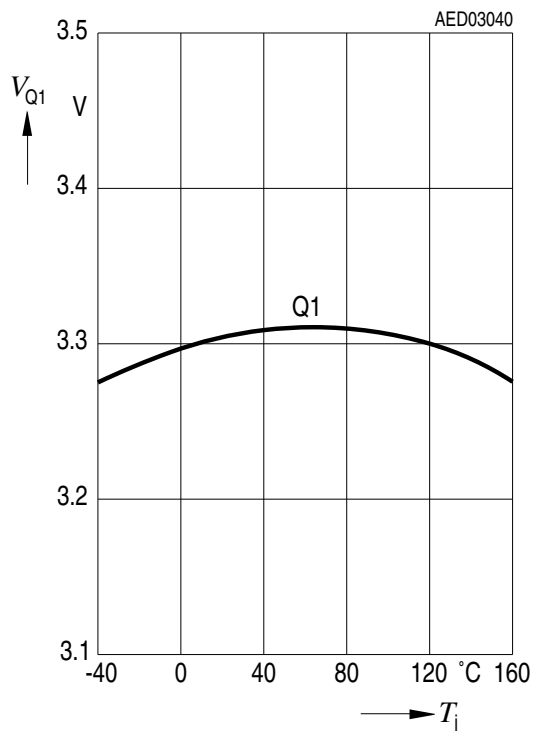

Drop Voltage V_{DR1} versus Output Current I_{Q1}

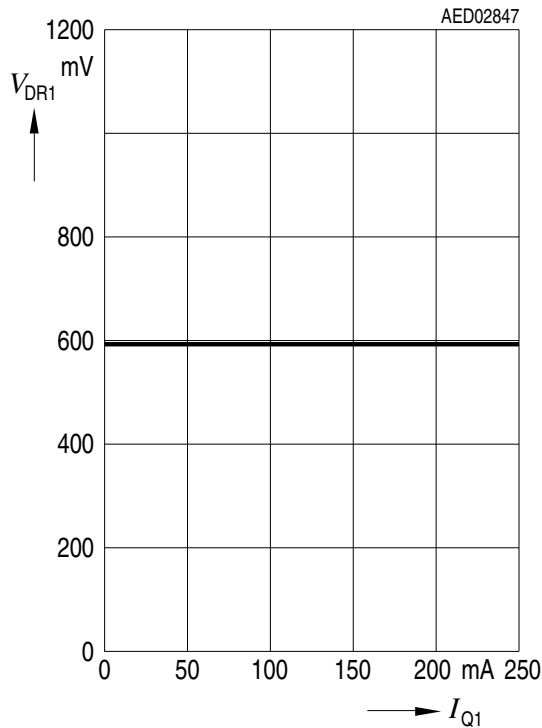

Drop Voltage V_{DR2} versus Output Current I_{Q2} EN ON

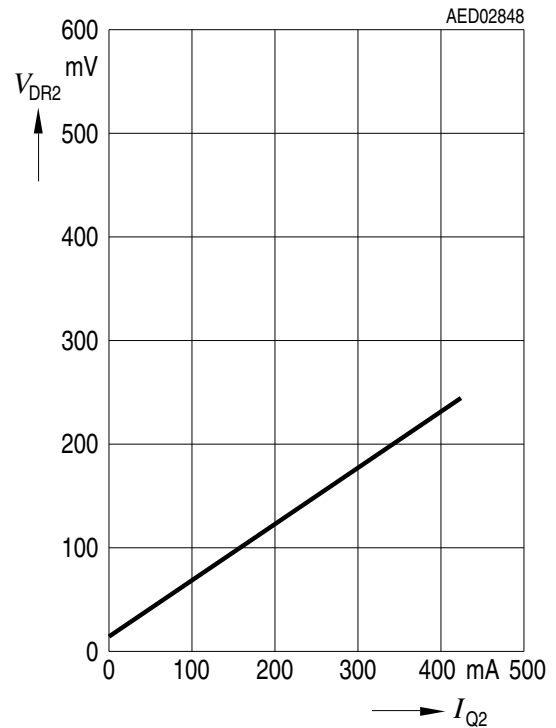

Current Consumption I_q versus Input Voltage V_I

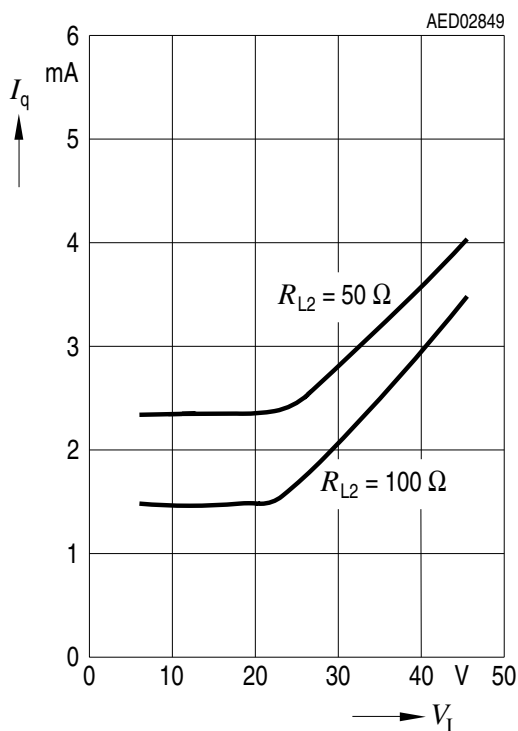

Current Consumption I_q versus Input Voltage V_I

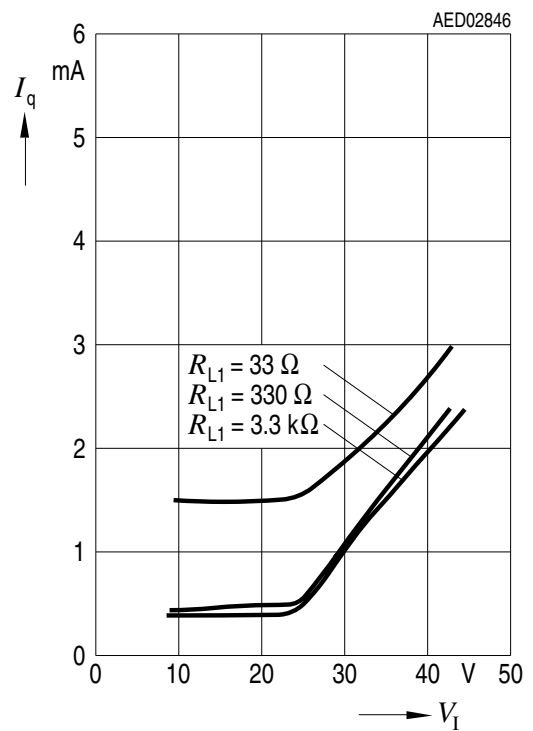

Current Consumption I_q versus Output Current I_{Q1}

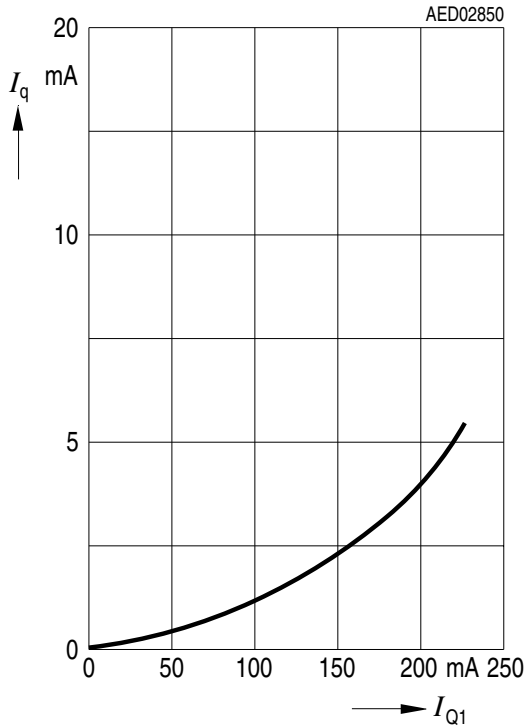

Current Consumption I_q versus Output Current I_{Q2}

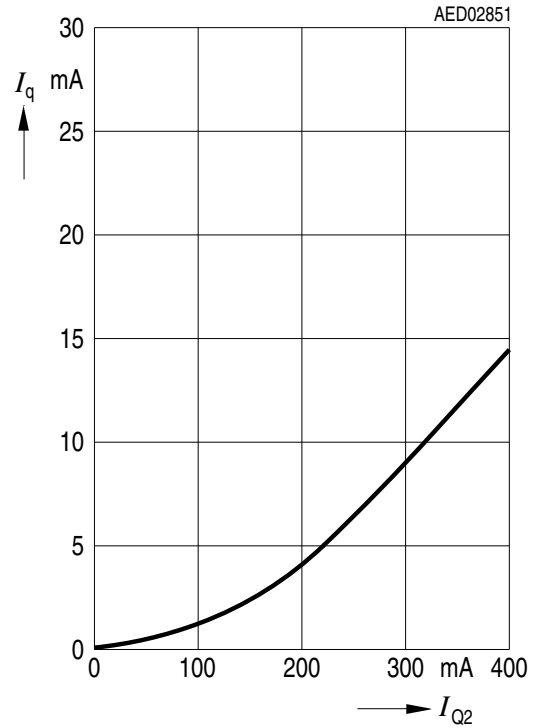

Output Voltage V_{Q1} versus Input Voltage V_I

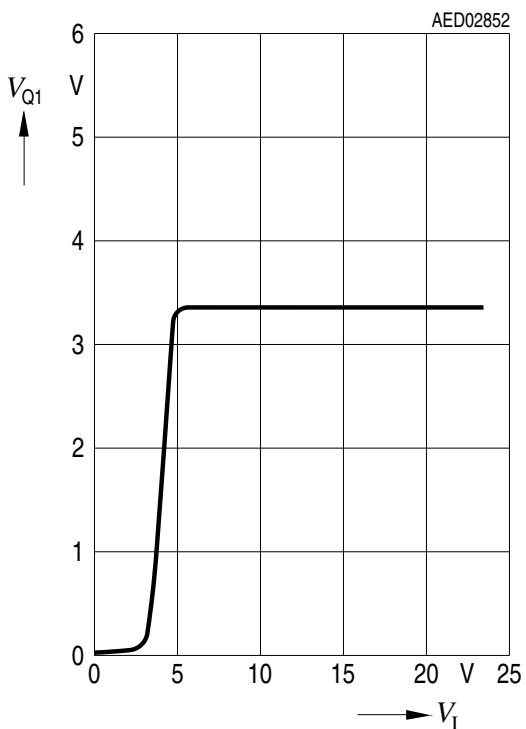

Output Voltage V_{Q2} versus Input Voltage V_I

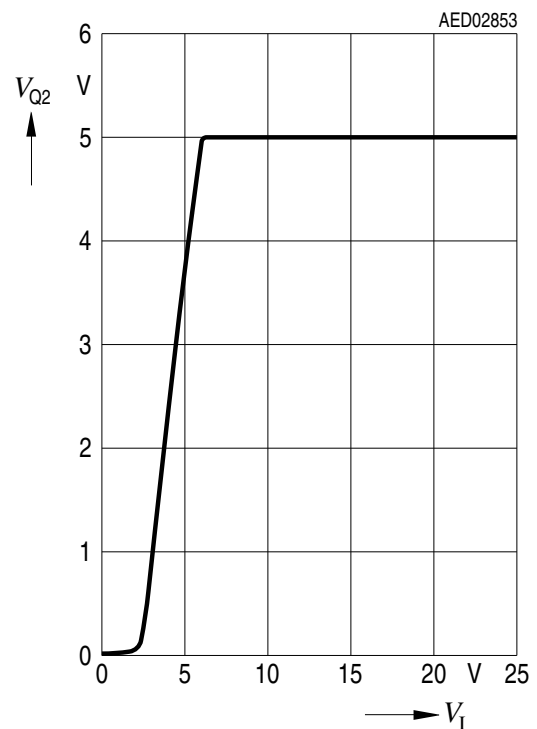

Package Outlines

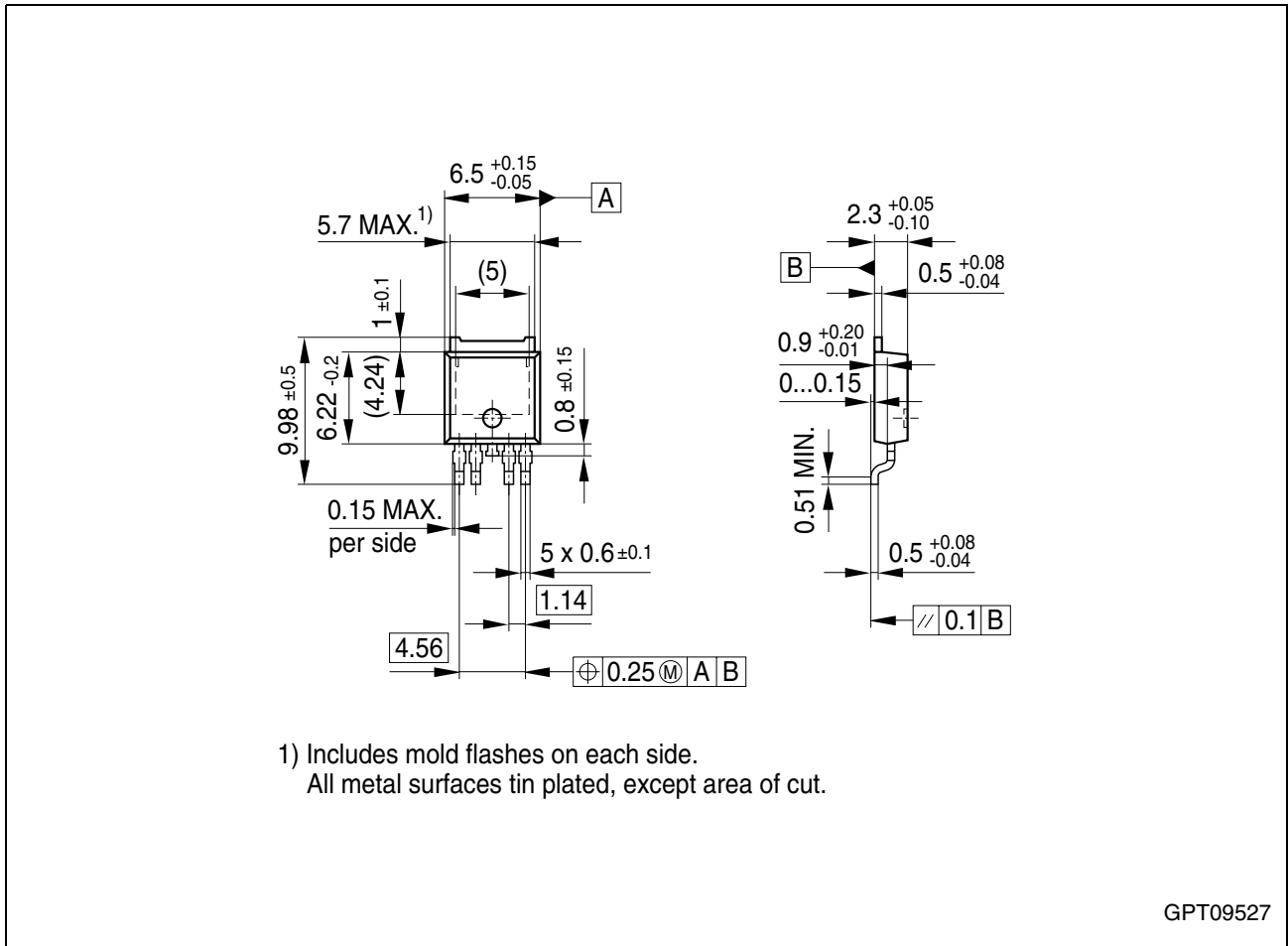

Figure 4 PG-TO252-5-11 (Plastic Transistor Single Outline)

Green Product (RoHS compliant)

To meet the world-wide customer requirements for environmentally friendly products and to be compliant with government regulations the device is available as a green product. Green products are RoHS-Compliant (i.e Pb-free finish on leads and suitable for Pb-free soldering according to IPC/JEDEC J-STD-020).

You can find all of our packages, sorts of packing and others in our Infineon Internet Page “Products”: <http://www.infineon.com/products>.

SMD = Surface Mounted Device

Dimensions in mm

Revision History

Version	Date	Changes
Rev. 2.5	2007-03-20	Initial version of RoHS-compliant derivate of TLE 4476 Page 1 : AEC certified statement added Page 1 and Page 12 : RoHS compliance statement and Green product feature added Page 1 and Page 12 : Package changed to RoHS compliant version Legal Disclaimer updated

Edition 2007-03-20

**Published by
Infineon Technologies AG
81726 Munich, Germany**

**© 2007 Infineon Technologies AG
All Rights Reserved.**

Legal Disclaimer

The information given in this document shall in no event be regarded as a guarantee of conditions or characteristics. With respect to any examples or hints given herein, any typical values stated herein and/or any information regarding the application of the device, Infineon Technologies hereby disclaims any and all warranties and liabilities of any kind, including without limitation, warranties of non-infringement of intellectual property rights of any third party.

Information

For further information on technology, delivery terms and conditions and prices, please contact the nearest Infineon Technologies Office (www.infineon.com).

Warnings

Due to technical requirements, components may contain dangerous substances. For information on the types in question, please contact the nearest Infineon Technologies Office.

Infineon Technologies components may be used in life-support devices or systems only with the express written approval of Infineon Technologies, if a failure of such components can reasonably be expected to cause the failure of that life-support device or system or to affect the safety or effectiveness of that device or system. Life support devices or systems are intended to be implanted in the human body or to support and/or maintain and sustain and/or protect human life. If they fail, it is reasonable to assume that the health of the user or other persons may be endangered.