

## High Voltage LED Series Chip on Board

# LCoogD



High efficacy COB LED package  
well-suited for use in spotlight applications

### Features & Benefits

- Chip on Board (COB) solution makes it easy to design in
- Simple assembly reduces manufacturing cost
- Low thermal resistance
- InGaN/GaN MQW LED with long time reliability



### Applications

- Spotlight / Downlight
- LED Retrofit Bulbs
- Outdoor Illumination

## Table of Contents

1.	Characteristics	-----	3
2.	Product Code Information	-----	5
3.	Typical Characteristics Graphs	-----	9
4.	Outline Drawing & Dimension	-----	12
5.	Reliability Test Items & Conditions	-----	13
6.	Label Structure	-----	14
7.	Packing Structure	-----	15
8.	Precautions in Handling & Use	-----	17

## 1. Characteristics

### a) Absolute Maximum Rating

Item	Symbol	Rating	Unit	Condition
Ambient / Operating Temperature	$T_a$	-40 ~ +105	°C	-
Storage Temperature	$T_{stg}$	-40 ~ +120	°C	-
LED Junction Temperature	$T_J$	140	°C	-
Case Temperature	$T_c$	105	°C	-
Forward Current	$I_F$	690	mA	-
Power Dissipation	$P_D$	25.9	W	-
ESD (HBM)	-	±2	kV	-
ESD (MM)	-	±0.5	kV	-

### b) Electro-optical Characteristics ( $I_F = 270 \text{ mA}$ , $T_J = 85 \text{ °C}$ )

Item	Unit	Rank	Min.	Typ.	Max.
Forward Voltage ( $V_F$ )	V	YZ	31.8	34.6	37.5
Color Rendering Index ( $R_a$ )	-	5	80	-	-
		7	90	-	-
Thermal Resistance (junction to chip point)	°C/W		-	1.7	-
Beam Angle	°		-	115	-
Nominal Power	W			10.1	

#### Notes:

- 1) The COB is tested in pulsed condition at rated test current (10 ms pulse width) and rated temperature ( $T_J = T_C = T_a = 85 \text{ °C}$ )
- 2) Samsung maintains measurement tolerance of: forward voltage = ±5 %, CRI = ±1
- 3) Refer to the derating curve, '3. Typical Characteristics Graph' designed within the range.

**c) Luminous Flux Characteristics (I<sub>F</sub> = 270 mA)**

CRI (R <sub>a</sub> ) Min.	Nominal CCT (K)	Flux Rank	Flux @ T <sub>J</sub> = 85 °C (lm)		
			Min.	Typ.	Max.
80	2700	H1	1149	1209	-
		D1	1209	1270	-
	3000	H2	1214	1278	-
		D1	1278	1342	-
	3500	H2	1249	1315	-
		D1	1315	1381	-
	4000	H2	1279	1347	-
		D1	1347	1414	-
	5000	H2	1289	1357	-
		D1	1357	1425	-
	5700	H2	1289	1357	-
		D1	1357	1425	-
	6500	H2	1274	1341	-
		D1	1341	1408	-

CRI (R <sub>a</sub> ) Min.	Nominal CCT (K)	Flux Rank	Flux @ T <sub>J</sub> = 85 °C (lm)		
			Min.	Typ.	Max.
90	2700	G8	986	1038	-
		D1	1038	1090	-
	3000	H0	1032	1087	-
		D1	1087	1141	-
	3500	H0	1066	1122	-
		D1	1122	1178	-
	4000	H0	1090	1147	-
		D1	1147	1204	-

**Notes:**

- 1) The COB is tested in pulsed operating condition at rated test current (10 ms pulse width) and rated temperature (T<sub>J</sub> = T<sub>C</sub> = 85 °C).
- 2) Samsung maintains measurement tolerance of: Luminous flux = ±7 %, CRI = ±1

## 2. Product Code Information

1	2	3	4	5	6	7	8	9	10	11	12	13	14	15	16	17	18
S	P	H	W	H	A	H	D	N	C	2	5	Y	Z	W	3	H	1

Digit	PKG Information	Code	Specification
1 2 3	Samsung Package High Power	<b>SPH</b>	
4 5	Color	<b>WH</b>	White
6	Product Version	<b>A</b>	
7 8	Form Factor	<b>HD</b>	COB
9	Lens Type	<b>N</b>	No lens
10	Wattage or Model	<b>C</b>	LC009D
11	Internal Code	<b>2</b>	
12	CRI & Sorting Temperature	<b>5</b> <b>7</b>	Min. 80 (85°C) Min. 90 (85°C)
13 14	Forward Voltage (V)	<b>YZ</b>	31.8~37.5
15	CCT (K)	<b>W</b> <b>V</b> <b>U</b> <b>T</b> <b>R</b> <b>Q</b> <b>P</b>	2700K 3000K 3500K 4000K 5000K 5700K 6500K
16	MacAdam Step	<b>2</b> <b>3</b>	MacAdam 2-step MacAdam 3-step
17 18	Luminous Flux (Lm)	<b>G8</b> <b>H0</b> <b>H1</b> <b>H2</b> <b>D1</b>	980 1000 1100 1200 Add rank

a) Binning Structure ( $I_F = 270 \text{ mA}$ ,  $T_J = 85 \text{ }^\circ\text{C}$ )

CRI ( $R_a$ ) Min.	Nominal CCT (K)	Product Code	$V_F$ Rank	Color Rank	Flux Rank	Flux Range ( $\Phi_v$ , lm)
80	2700	SPHWAHDNC25YZW2H1	YZ	W2	H1	1149 ~
		SPHWAHDNC25YZW3H1		W3		
		SPHWAHDNC25YZW2D1		W2	D1	1209 ~
		SPHWAHDNC25YZW3D1		W3		
	3000	SPHWAHDNC25YZV2H2	YZ	V2	H2	1214 ~
		SPHWAHDNC25YZV3H2		V3		
		SPHWAHDNC25YZV2D1		V2	D1	1278 ~
		SPHWAHDNC25YZV3D1		V3		
	3500	SPHWAHDNC25YZU2H2	YZ	U2	H2	1249 ~
		SPHWAHDNC25YZU3H2		U3		
		SPHWAHDNC25YZU2D1		U2	D1	1315 ~
		SPHWAHDNC25YZU3D1		U3		
	4000	SPHWAHDNC25YZT2H2	YZ	T2	H2	1279 ~
		SPHWAHDNC25YZT3H2		T3		
		SPHWAHDNC25YZT2D1		T2	D1	1347 ~
		SPHWAHDNC25YZT3D1		T3		
	5000	SPHWAHDNC25YZR3H2	YZ	R3	H2	1289 ~
		SPHWAHDNC25YZR3D1			D1	1357 ~
	5700	SPHWAHDNC25YZQ3H2	YZ	Q3	H2	1289 ~
		SPHWAHDNC25YZQ3D1			D1	1357 ~
6500	SPHWAHDNC25YZP3H2	YZ	P3	H2	1274 ~	
	SPHWAHDNC25YZP3D1			D1	1341 ~	

CRI (R <sub>a</sub> ) Min.	Nominal CCT (K)	Product Code	V <sub>F</sub> Rank	Color Rank	Flux Rank	Flux Range (Φ <sub>v</sub> , lm)
90	2700	SPHWHAHDC27YZW2G8	YZ	W2	G8	986 ~
		SPHWHAHDC27YZW3G8		W3		
		SPHWHAHDC27YZW2D1		W2	D1	1038 ~
		SPHWHAHDC27YZW3D1		W3		
	3000	SPHWHAHDC27YZV2H0	YZ	V2	H0	1032 ~
		SPHWHAHDC27YZV3H0		V3		
		SPHWHAHDC27YZV2D1		V2	D1	1087 ~
		SPHWHAHDC27YZV3D1		V3		
	3500	SPHWHAHDC27YZU2H0	YZ	U2	H0	1066 ~
		SPHWHAHDC27YZU3H0		U3		
		SPHWHAHDC27YZU2D1		U2	D1	1122 ~
		SPHWHAHDC27YZU3D1		U3		
	4000	SPHWHAHDC27YZT2H0	YZ	T2	H0	1090 ~
		SPHWHAHDC27YZT3H0		T3		
		SPHWHAHDC27YZT2D1		T2	D1	1147 ~
		SPHWHAHDC27YZT3D1		T3		

b) Chromaticity Region & Coordinates ( $I_F = 270 \text{ mA}$ ,  $T_J = 85 \text{ }^\circ\text{C}$ )

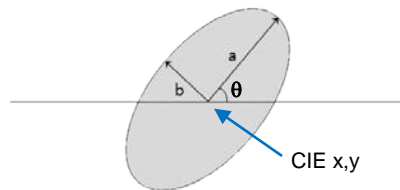
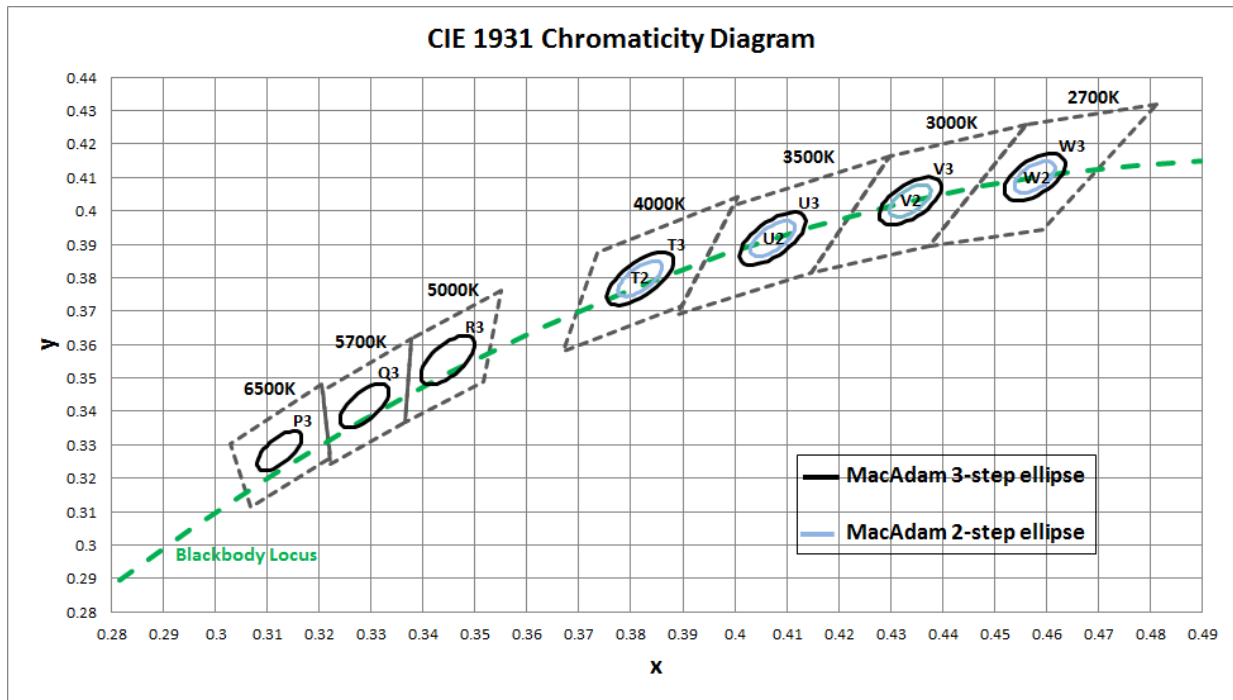

MacAdam Ellipse (W2, W3)					
Step	CIE x	CIE y	$\theta$	a	b
2-step	0.4578	0.4101	53.70	0.0054	0.0028
3-step	0.4578	0.4101	53.70	0.0081	0.0042

MacAdam Ellipse (V2, V3)					
Step	CIE x	CIE y	$\theta$	a	b
2-step	0.4338	0.403	53.22	0.0056	0.0027
3-step	0.4338	0.4030	53.22	0.0083	0.0041

MacAdam Ellipse (U2, U3)					
Step	CIE x	CIE y	$\theta$	a	b
2-step	0.4073	0.3917	54.00	0.0062	0.0028
3-step	0.4073	0.3917	54.00	0.0093	0.0041

MacAdam Ellipse (T2, T3)					
Step	CIE x	CIE y	$\theta$	a	b
2-step	0.3818	0.3797	53.72	0.0063	0.0027
3-step	0.3818	0.3797	53.72	0.0094	0.0040

MacAdam Ellipse (R3)					
Step	CIE x	CIE y	$\theta$	a	b
3-step	0.3447	0.3553	59.62	0.0082	0.0035

MacAdam Ellipse (Q3)					
Step	CIE x	CIE y	$\theta$	a	b
3-step	0.3287	0.3417	59.0950	0.0075	0.0032

MacAdam Ellipse (P3)					
Step	CIE x	CIE y	$\theta$	a	b
3-step	0.3123	0.3282	58.5700	0.0067	0.0029

**Note:**

Samsung maintains measurement tolerance of:  $C_x, C_y = \pm 0.005$



### 3. Typical Characteristics Graphs

#### a) Spectrum Distribution ( $I_f = 270 \text{ mA}$ , $T_J = 85 \text{ }^\circ\text{C}$ )

CCT: 2700 K (80 CRI)

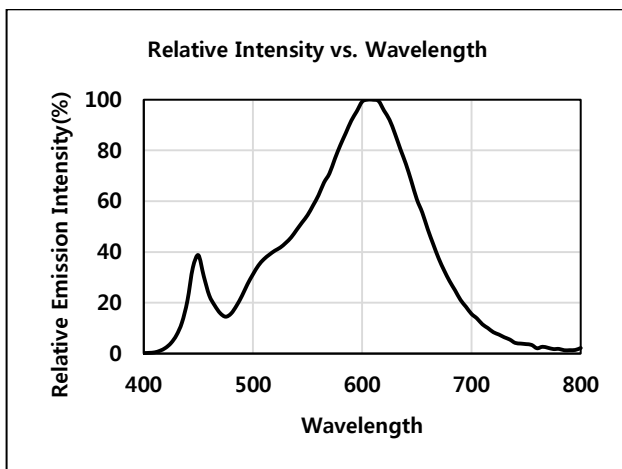

CCT: 3000 K (80 CRI)

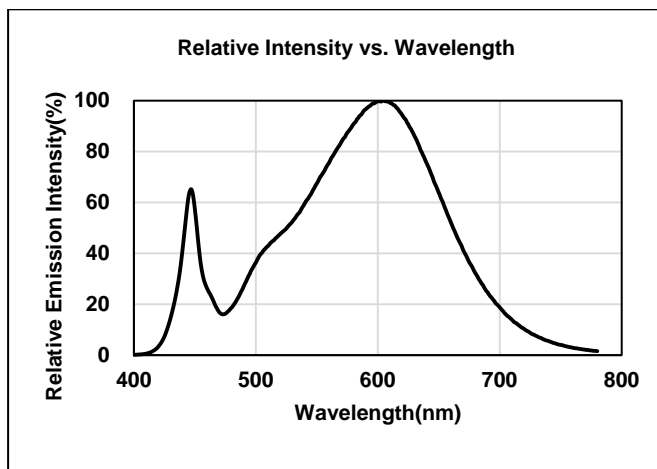

CCT: 3500 K (80 CRI)

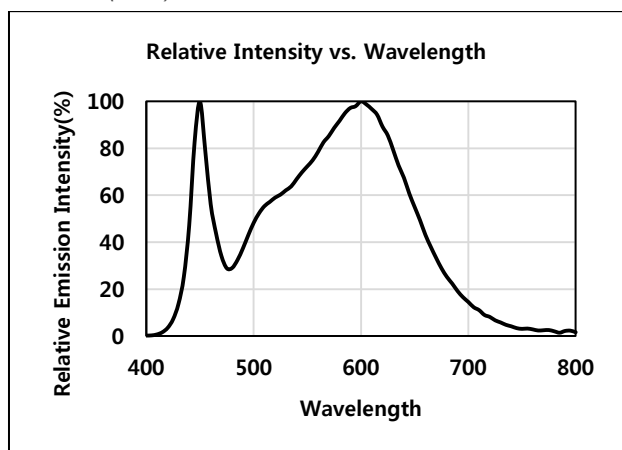

CCT: 4000 K (80 CRI)

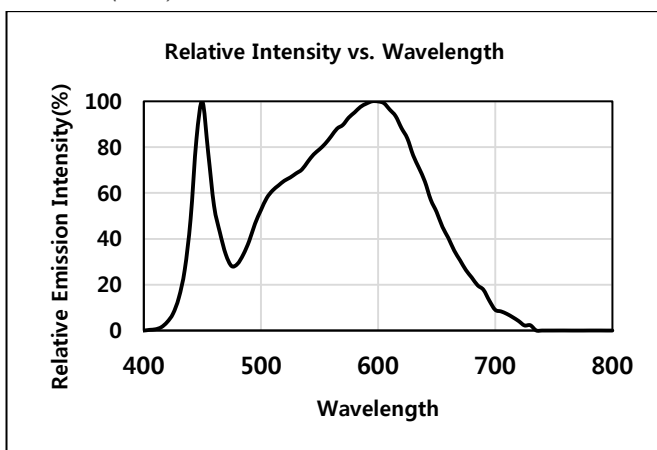

CCT: 5000 K (80 CRI)

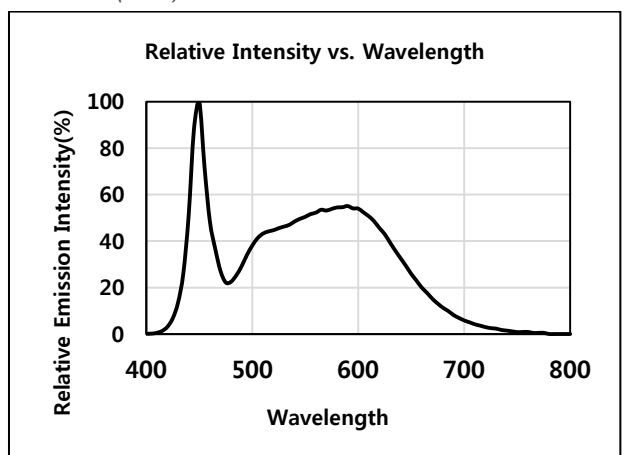

CCT: 5700 K (80 CRI)

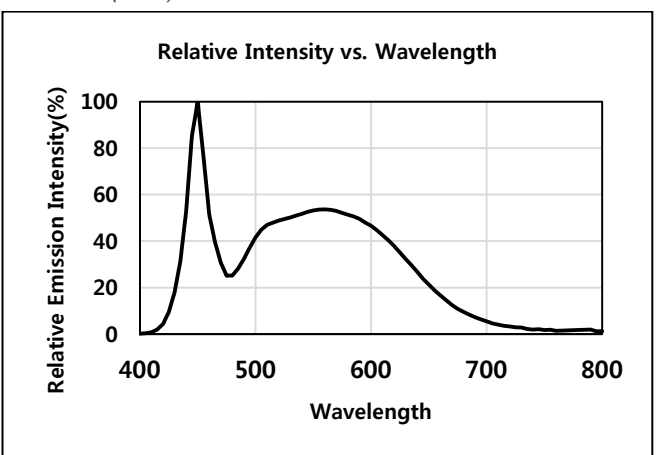

CCT: 6500 K (80 CRI)

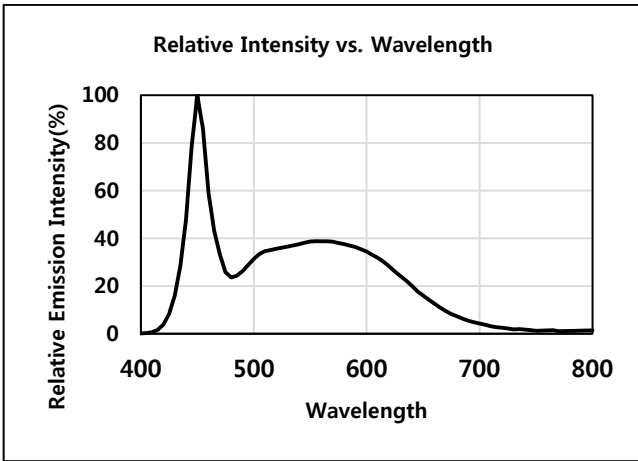

**b) Forward Current Characteristics ( $T_j = 85^\circ\text{C}$ )**

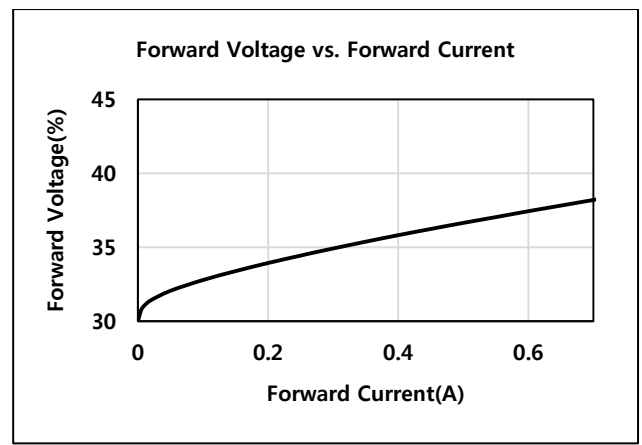
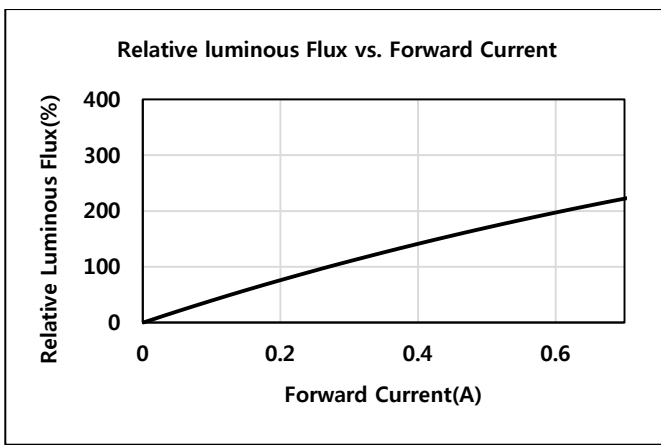

**C) Temperature Characteristics ( $I_F = 270\text{mA}$ )**

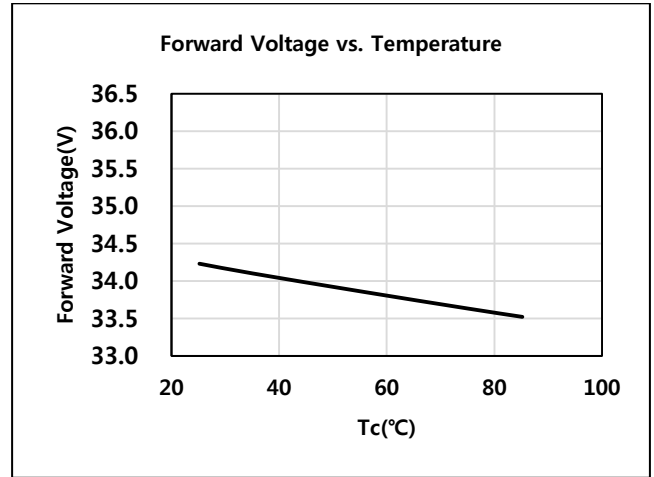
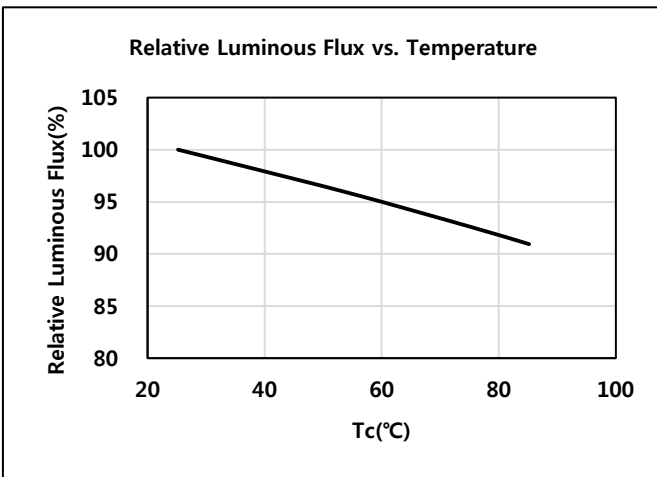

d) Color Shift Characteristics ( $T_J = 25\text{ }^\circ\text{C}$ ,  $I_F = 270\text{mA}$ , CRI80+)

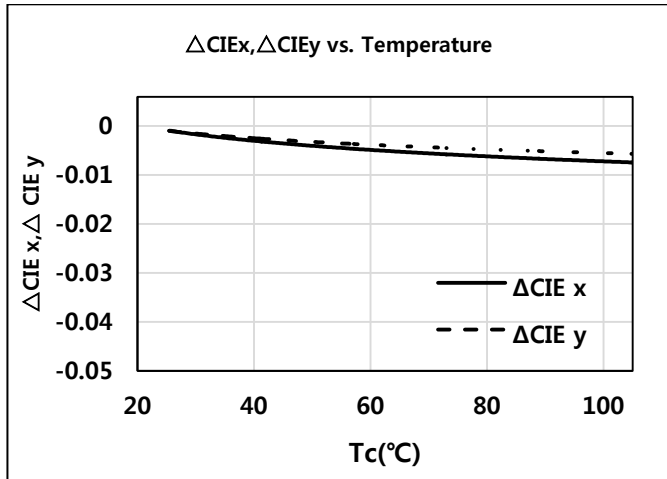
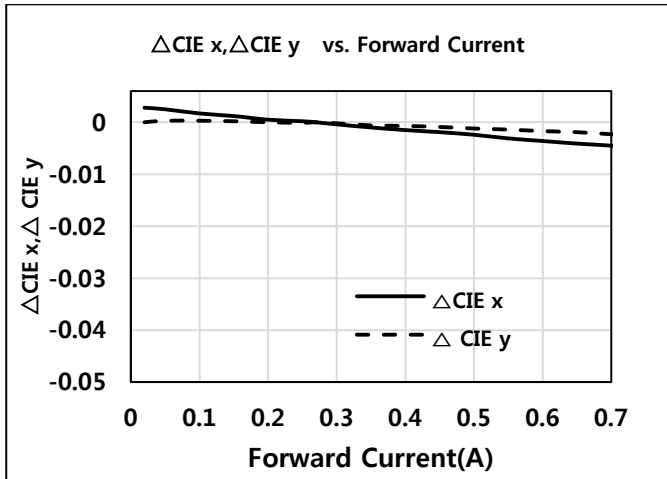

e) Beam Angle Characteristics ( $I_F = 270\text{ mA}$ ,  $T_J = 85\text{ }^\circ\text{C}$ )

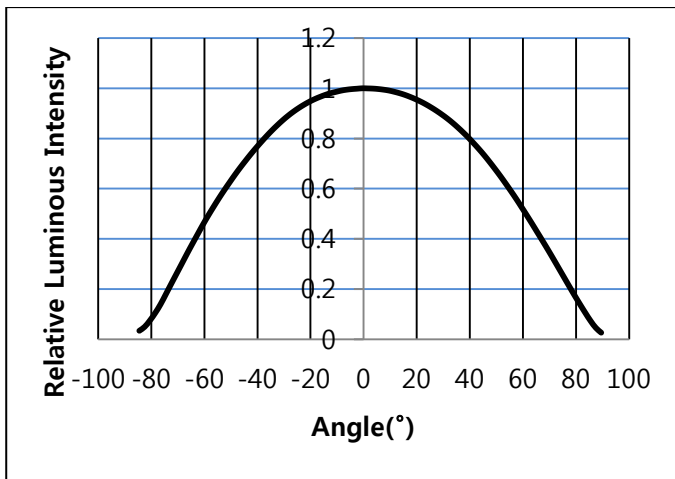

f) Derating Characteristics

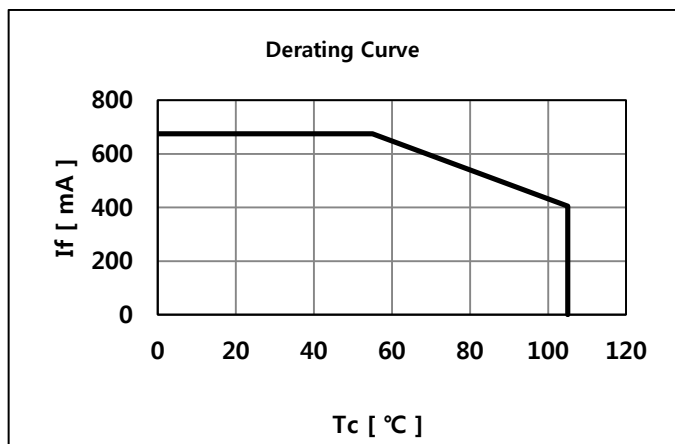

#### 4. Outline Drawing & Dimension

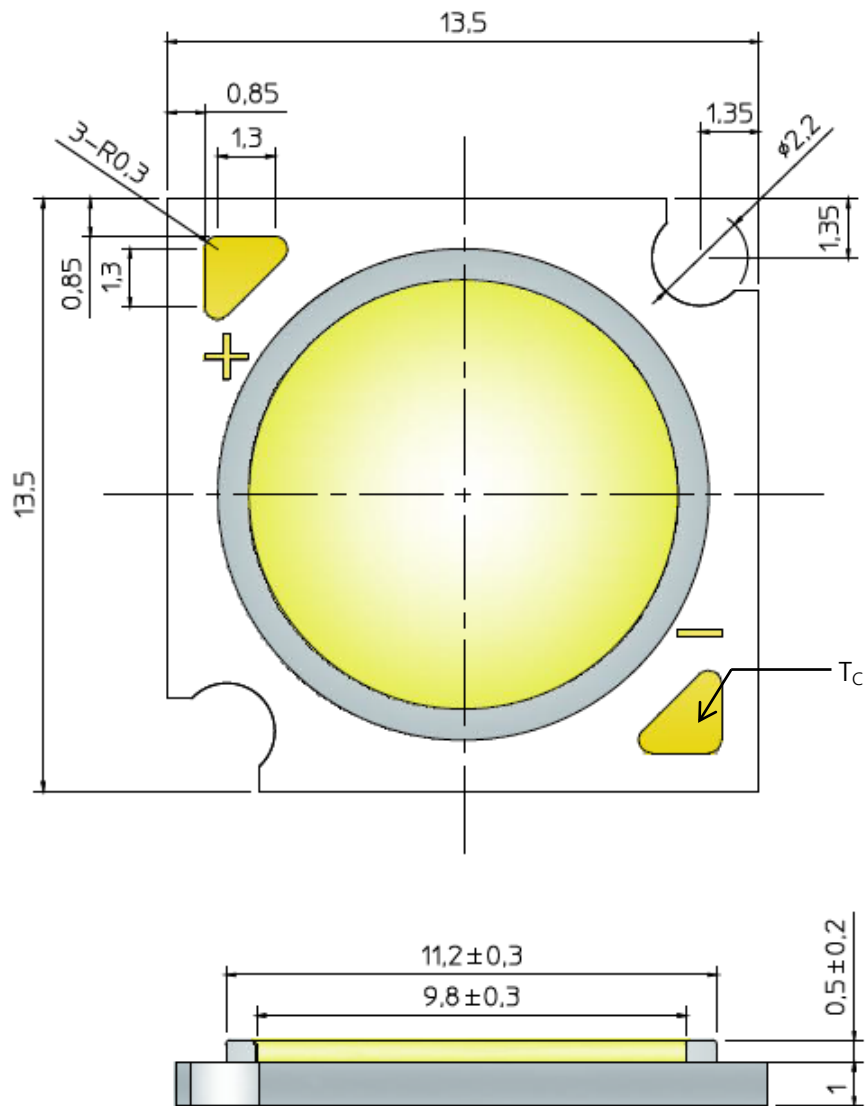

1. Unit: mm
2. Tolerance:  $\pm 0.30$  mm

Item	Dimension	Tolerance	Unit
Length	13.5	$\pm 0.15$	mm
Width	13.5	$\pm 0.15$	mm
Height	1.50	$\pm 0.20$	mm
Light Emitting Surface (LES) Diameter	9.8	$\pm 0.30$	mm

Note: Denoted product information above is only an example  
( LC009D, CRI80+, 3000K )

## 5. Reliability Test Items & Conditions

### a) Test Items

Test Item	Test Condition	Test Hour / Cycle
High Temperature Humidity Life Test	60 °C, 90 % RH,, DC Derating, $I_F$	1000 h
High Temperature Life Test	85 °C, DC Derating, $I_F$	1000 h
Low Temperature Life Test	-40 °C, DC , $I_F = 480$ mA	1000 h
Pulsed Operating Life Test	55 °C, Pulse width 100 $\mu$ s, duty cycle 3 %	1000 h
High Temperature Storage	120 °C	1000 h
Low Temperature Storage	-40 °C	1000 h
Temperature Humidity Storage	60 °C, 90% RH	1000h
Temperature Cycle On/Off Test	-40 °C / 85 °C each 20 min, 30 min transfer power on/off each 5 min, DC Derating, $I_F = \text{max}$	100 cycles
ESD (HBM)	R <sub>1</sub> : 10 M $\Omega$ R <sub>2</sub> : 1.5 k $\Omega$ C: 100 pF V: $\pm 2$ kV	5 times
ESD (MM)	R <sub>1</sub> : 10 M $\Omega$ R <sub>2</sub> : 0 k $\Omega$ C: 200 pF V: $\pm 0.2$ kV	5 times
Vibration Test	20 ~ 80 Hz (displacement: 0.06 inch, max. 20 g) 80 ~ 2 kHz (max. 20 g) min. frequency $\leftrightarrow$ max. frequency 4 min transfer	4 times
Mechanical Shock Test	1500 g, 0.5 ms each of the 6 surfaces (3 axis x 2 sides)	5 times
Sulfur Resistance	25 °C, 75%, H <sub>2</sub> S 15 ppm	504h

### b) Criteria for Judging the Damage

Item	Symbol	Test Condition ( $T_c = 25$ °C)	Limit	
			Min.	Max.
Forward Voltage	$V_F$	$I_F = 270$ mA	L.S.L. * 0.9	U.S.L. * 1.1
Luminous Flux	$\Phi_v$	$I_F = 270$ mA	L.S.L * 0.7	U.S.L * 1.3

## 6. Label Structure

### a) Label Structure

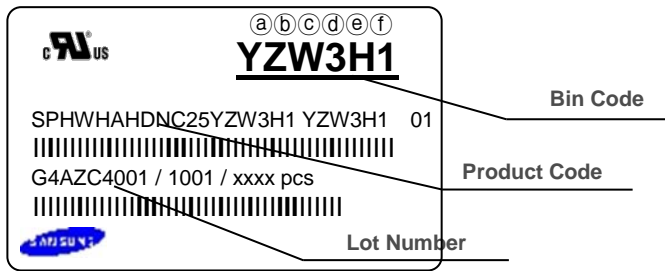

Note: Denoted bin code and product code above is only an example (see description on page 5)

Bin Code:

- ①②: Forward Voltage bin (refer to page 11)
- ③④: Chromaticity bin (refer to page 9-10)
- ⑤⑥: Luminous Flux bin (refer to page 6)

### b) Lot Number

The lot number is composed of the following characters:

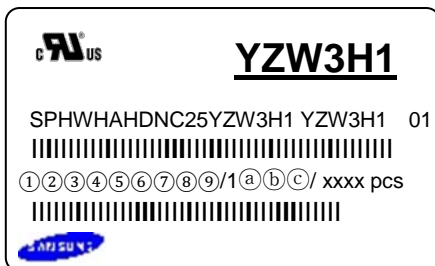

① ③④⑤⑥⑦⑧⑨ / 1(a)(b)(c) / xxxx pcs

- ① : Production site (S: Giheung, Korea, G: Tianjin, China)
- ② : 4 (LED)
- ③ : Product state (A: Normal, B: Bulk, C: First Production, R: Reproduction, S: Sample)
- ④ : Year (Z: 2015, A: 2016, B: 2017...)
- ⑤ : Month (1~9, A, B, C)
- ⑥⑦⑧⑨ : Day (1~9, A, B~V)
- ①②③ : Product serial number (001 ~ 999)

## 7. Packing Structure

Packing material	Max. quantity in pcs of COB	Dimension(mm)			
		Length	Width	Height	Tolerance
<b>Tray</b>	30	160	180	10	1.0
<b>Aluminum Bag</b>	60(2 trays)	210	241		10
<b>Inner Box</b>	240	230	84	260	2
<b>Outer Box</b>	2400	476	445	272	5

### a) Packing Structure

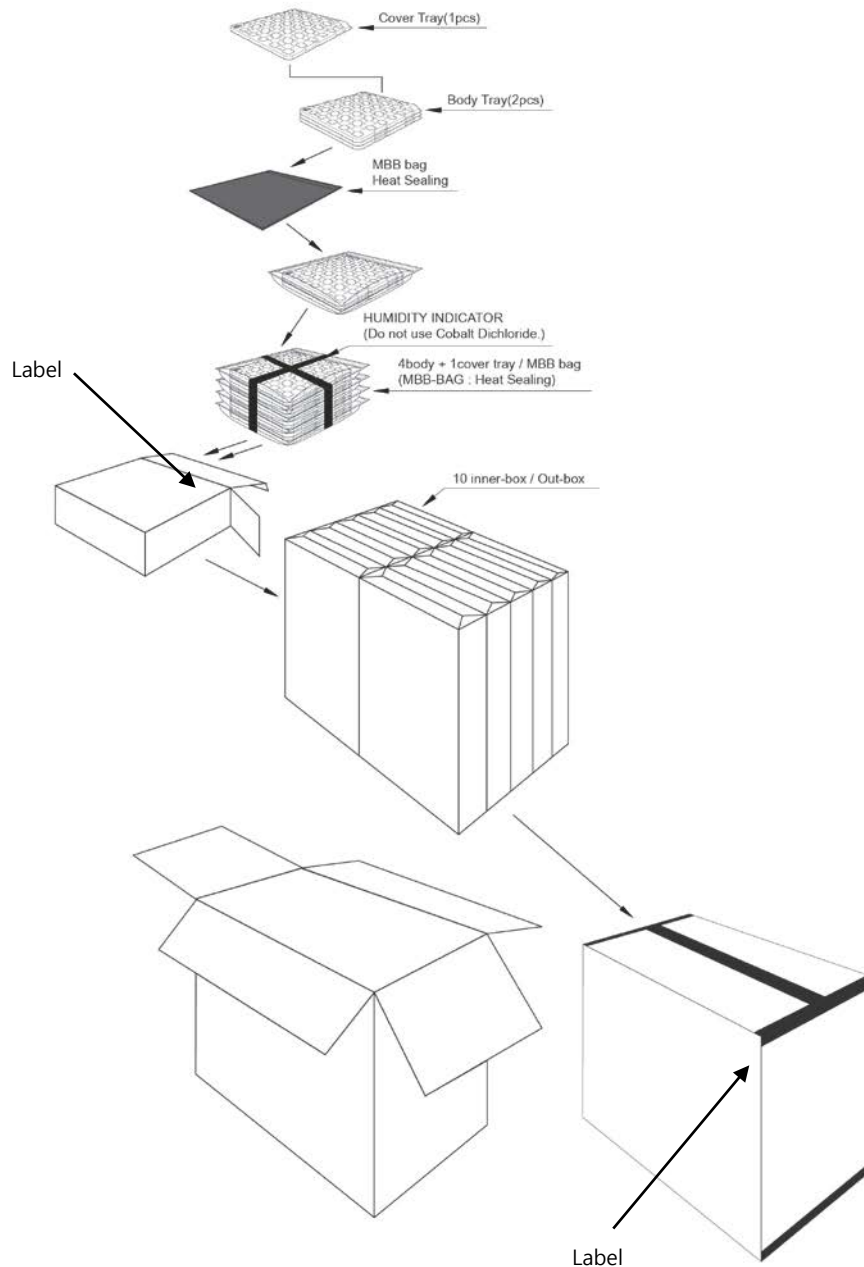

b) Tray

① Cover

② Body

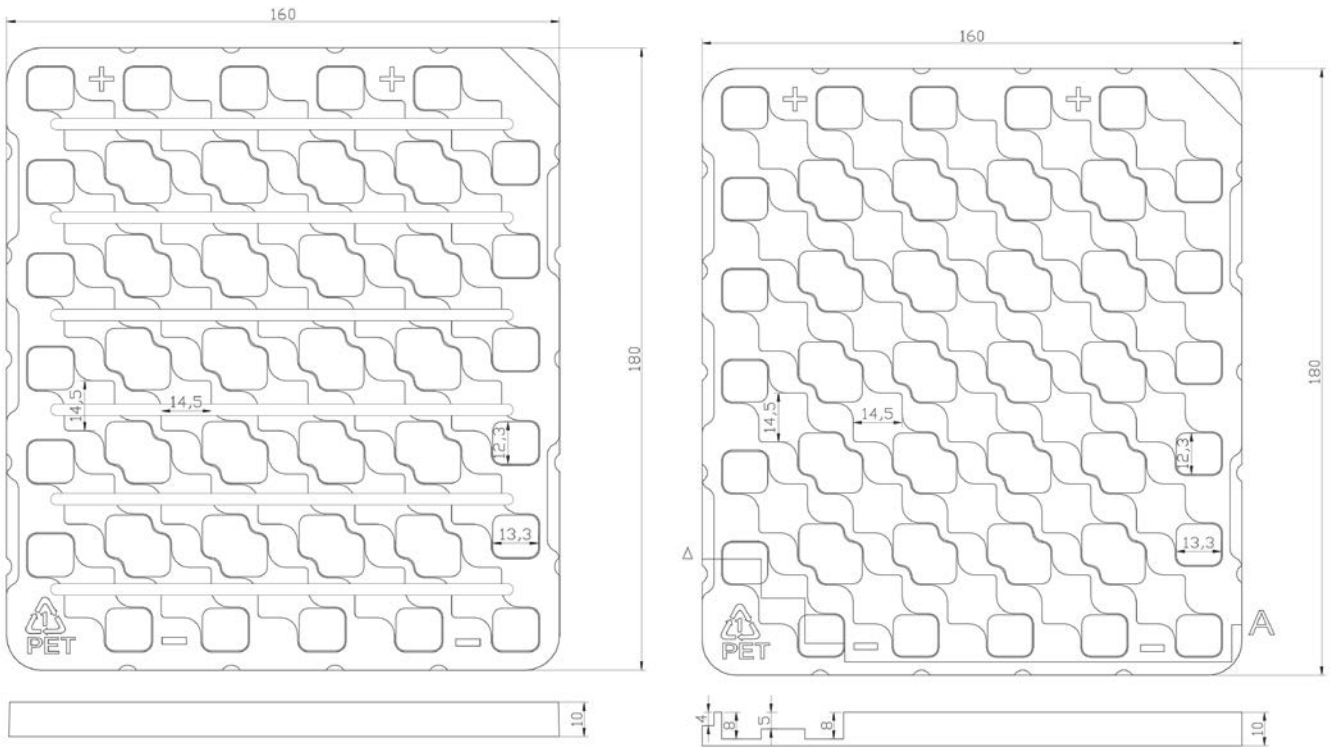

c) Aluminum Vinyl Packing Bag

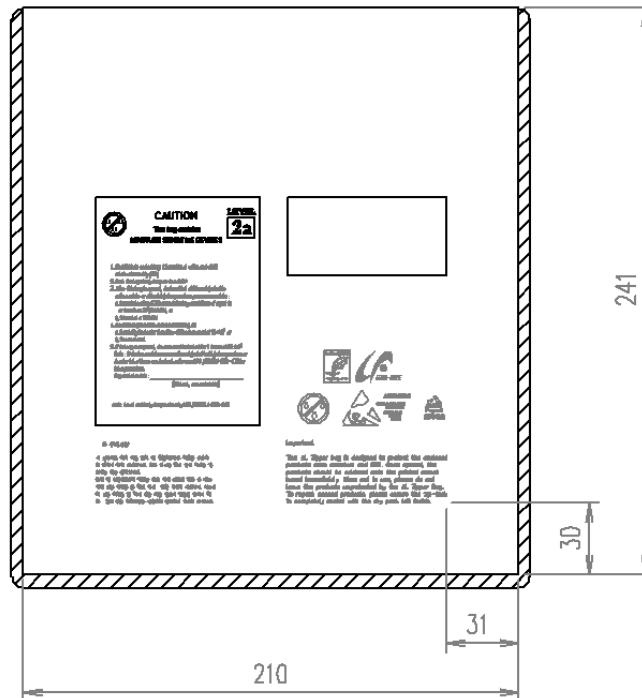



## 8. Precautions in Handling & Use

- 1) This device should not be used in any type of fluid such as water, oil, organic solvent, etc. When cleaning is required, IPA is recommended as the cleaning agent. Some solvent-based cleaning agent may damage the silicone resins used in the device.
- 2) LEDs must be stored in a clean environment. If the LEDs are to be stored for three months or more after being shipped from Samsung, they should be packed with a nitrogen-filled container (shelf life of sealed bags is 12 months at temperature 0~40 °C, 0~90 % RH).
- 3) After storage bag is opened, device subjected to soldering, solder reflow, or other high temperature processes must be:
  - a. Mounted within 672 hours (28 days) at an assembly line with a condition of no more than 30 °C / 60 % RH, or
  - b. Stored at <10 % RH
- 4) Repack unused products with anti-moisture packing, fold to close any opening and then store in a dry place.
- 5) Devices require baking before mounting, if humidity card reading is >60 % at 23 ± 5 °C.
- 6) Devices must be baked for 1 hour at 60 ± 5 °C, if baking is required.
- 7) The LEDs are sensitive to the static electricity and surge current. It is recommended to use a wrist band or anti-electrostatic glove when handling the LEDs. If voltage exceeding the absolute maximum rating is applied to LEDs, it may cause damage or even destruction to LED devices. Damaged LEDs may show some unusual characteristics such as increase in leakage current, lowered turn-on voltage, or abnormal lighting of LEDs at low current.
- 8) VOCs (Volatile Organic Compounds) can be generated from adhesives, flux, hardener or organic additives used in luminaires (fixtures). Transparent LED silicone encapsulant is permeable to those chemicals and they may lead to a discoloration of encapsulant when they exposed to heat or light. This phenomenon can cause a significant loss of light emitted (output) from the luminaires. In order to prevent these problems, we recommend users to know the physical properties of materials used in luminaires and they must be carefully selected.
- 9) The resin area is very sensitive, please do not handle, press, touch, rub, clean, or pick by with tweezers on it. Instead, please pick at the handling area as indicated below.

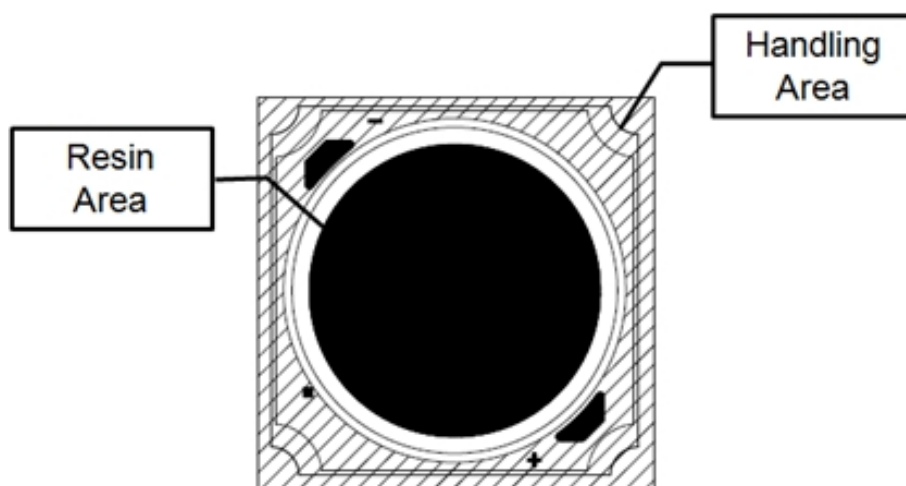

# Legal and additional information.

## [About Samsung Electronics Co., Ltd.](#)

Samsung Electronics Co., Ltd. inspires the world and shapes the future with transformative ideas and technologies, redefining the worlds of TVs, smartphones, wearable devices, tablets, cameras, digital appliances, printers, medical equipment, network systems and semiconductors.

We are also leading in the Internet of Things space through, among others, our Digital Health and Smart Home initiatives. We employ 307,000 people across 84 countries. To discover more, please visit our official website at [www.samsung.com](http://www.samsung.com) and our official blog at [global.samsungtomorrow.com](http://global.samsungtomorrow.com).

Copyright © 2015 Samsung Electronics Co., Ltd. All rights reserved.

Samsung is a registered trademark of Samsung Electronics Co., Ltd.

Specifications and designs are subject to change without notice. Non-metric weights and measurements are approximate. All data were deemed correct at time of creation. Samsung is not liable for errors or omissions. All brand, product, service names and logos are trademarks and/or registered trademarks of their respective owners and are hereby recognized and acknowledged.

Samsung Electronics Co., Ltd.

95, Samsung 2-ro

Giheung-gu

Yongin-si, Gyeonggi-do, 446-711

KOREA

[www.samsungled.com](http://www.samsungled.com)

